

# Opera



## Finiture / Finishes



BM | Bronzo opaco /  
Matt bronze



OB | Ottone bronzato  
satinato / Bronzed  
brass + satin brass



OF | Oro francese /  
French gold



OZ | Oro zecchino /  
Gold plated



PM | Patiné / Patiné  
mat

Le forme severe del Neoclassicismo infondono uno stile rigoroso a questa collezione, caratterizzata da linee orizzontali e verticali che sottolineano l'imponenza del design.

*The severe forms of Neoclassicism instil a meticulous style in this collection, characterised by horizontal and vertical lines that highlight the grandeur of the design.*



**BENZOVILLE**  
BY UNIQUE INNOVATIONS

**lineacali**

# Collezione / Collection

1055 RB 112  
Maniglia con rosetta  
art.112 / Door handle  
on rose art.112

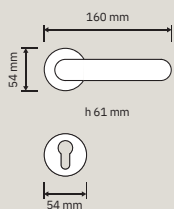
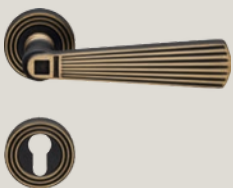

1055 PT 070  
Pomolo a tirare /  
Fixed knob

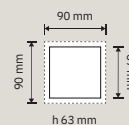

1055 RB 114  
Maniglia con rosetta  
art.114 / Door handle  
on rose art.114

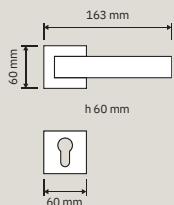

1055 FP  
Pomolo fisso con  
placca / Fixed knob  
on plate

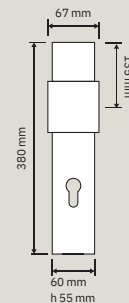

1055 PL  
Maniglia con placca /  
Door handle on plate

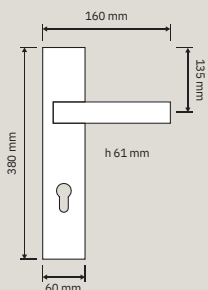

1055 MN 240  
Maniglione / Pull  
handle

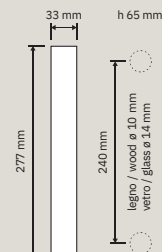

1055 DK  
Maniglia per finestra  
con movimento DK 4  
posizioni / Window  
handle with DK  
movement 4 clicks

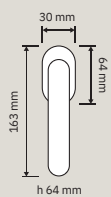

1055 SK  
Maniglia per finestra  
con movimento  
DK SmartBlock /  
Window handle  
with DK SmartBlock  
movement

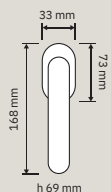

# Collezione / Collection

1055 AP  
Maniglione  
accoppiato su placca  
/ Set pull handles on  
plate

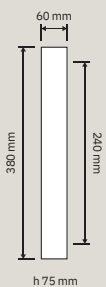

1055 ED/ES  
Set d'entrata:  
maniglia (dx o sx)  
+ pomolo fisso e  
maniglione con  
placca / Entrance set:  
door handle (right or  
left) + fixed knob and  
pull handle on plate

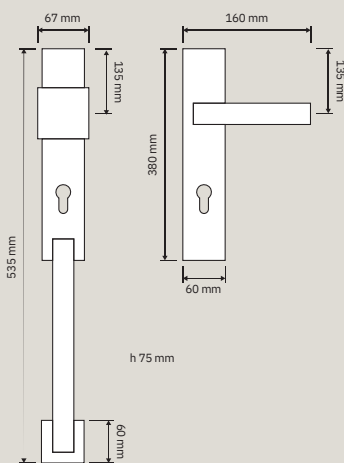

1055 KD/KS  
Maniglia (dx o sx)  
+ pomolo fisso con  
placca / Door handle  
(right or left) + fixed  
knob on plate

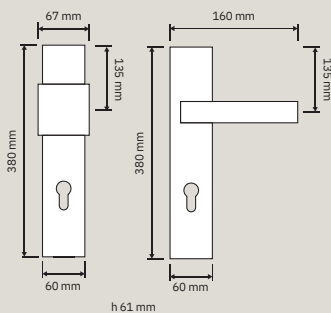



La versione con placca è l'apoteosi dello stile Neoclassico che trae ispirazione dall'architettura greca e romana.

*The version with plate is the apotheosis of the Neoclassical style that draws inspiration from Greek and Roman architecture.*